

Article number: 20355124

Description: E+G Mounting tool, GN 355.1-24

## Measures

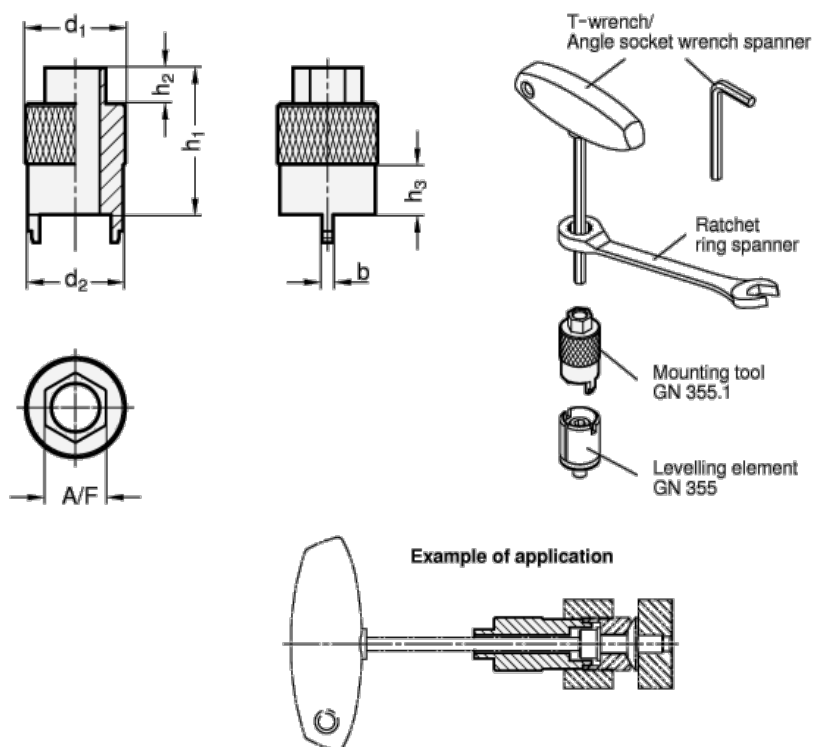

A/F	= 13
b	= 4
d1	= 24
d2	= 225
h1	= 43
h2	= 9
h3	= 11
Max torque pres Nm	= 75

Weight in (g) = 68